

# Africa

# Coloring Book

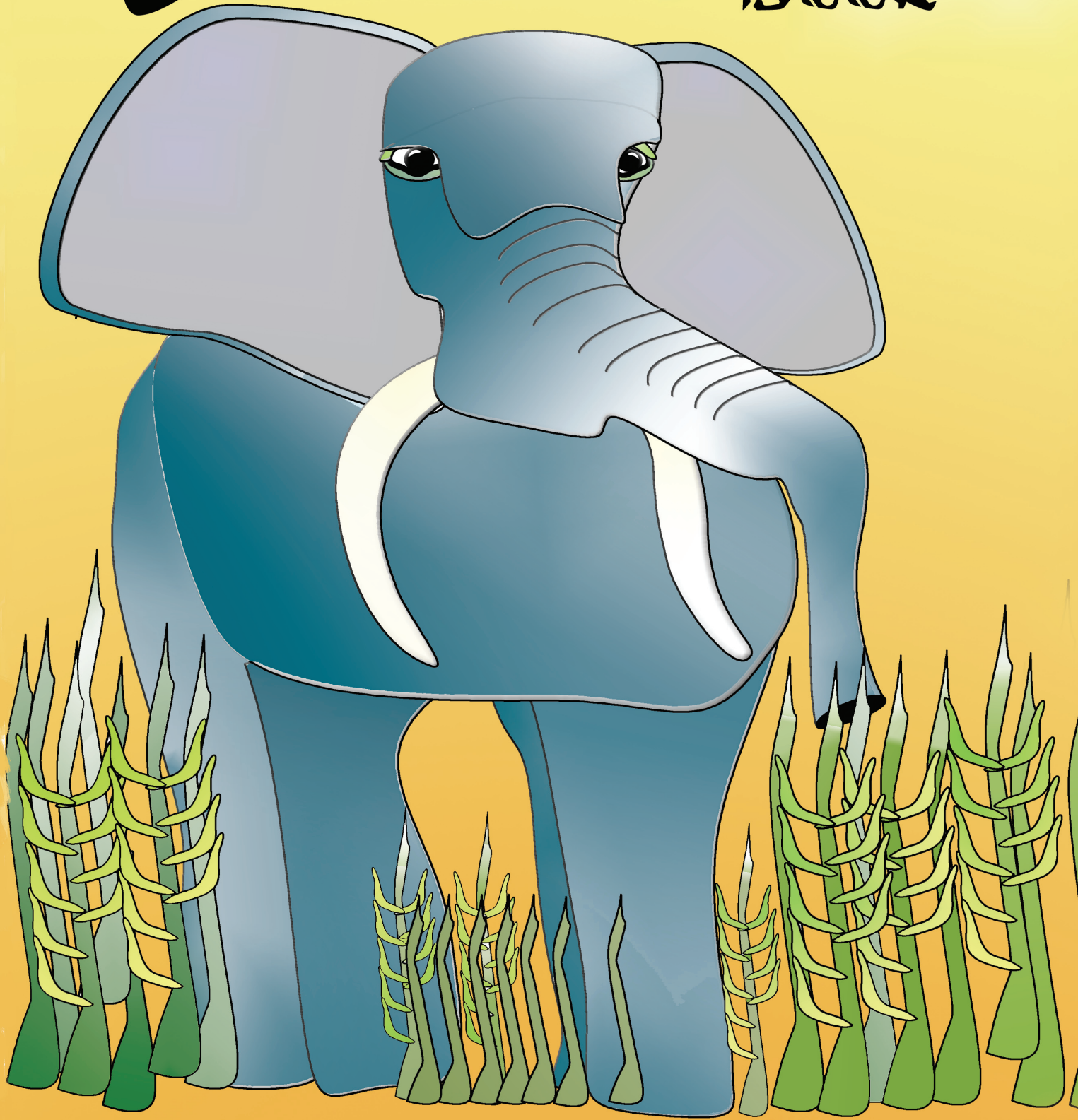



# Map of Africa



Africa has more than 50 countries, and more than 680 million people!

# Balafon

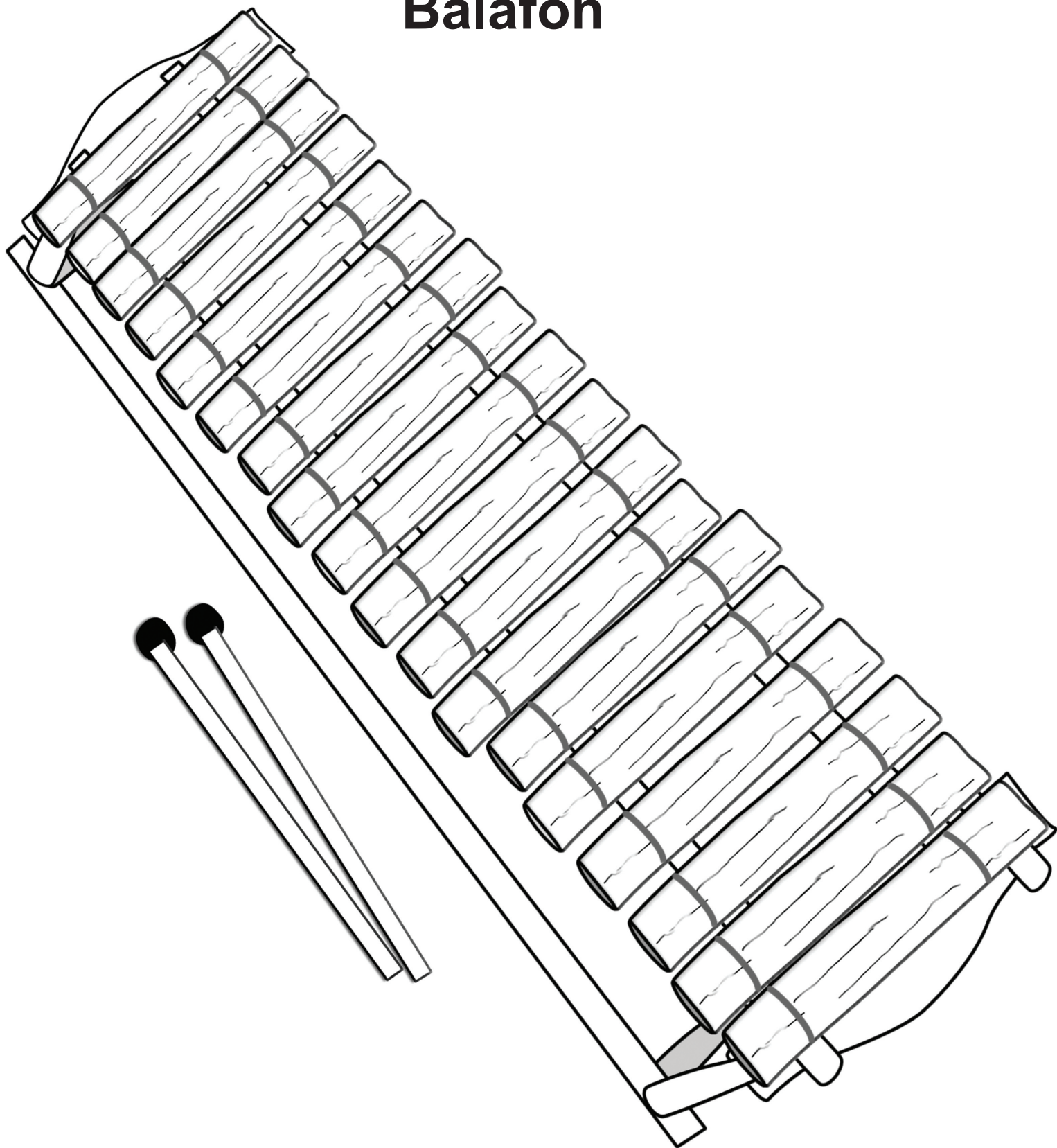

The balafon is a wooden musical instrument. Each wooden plate makes a different sound when you hit it with one of the mallets.

# Child of the heavens symbol

5

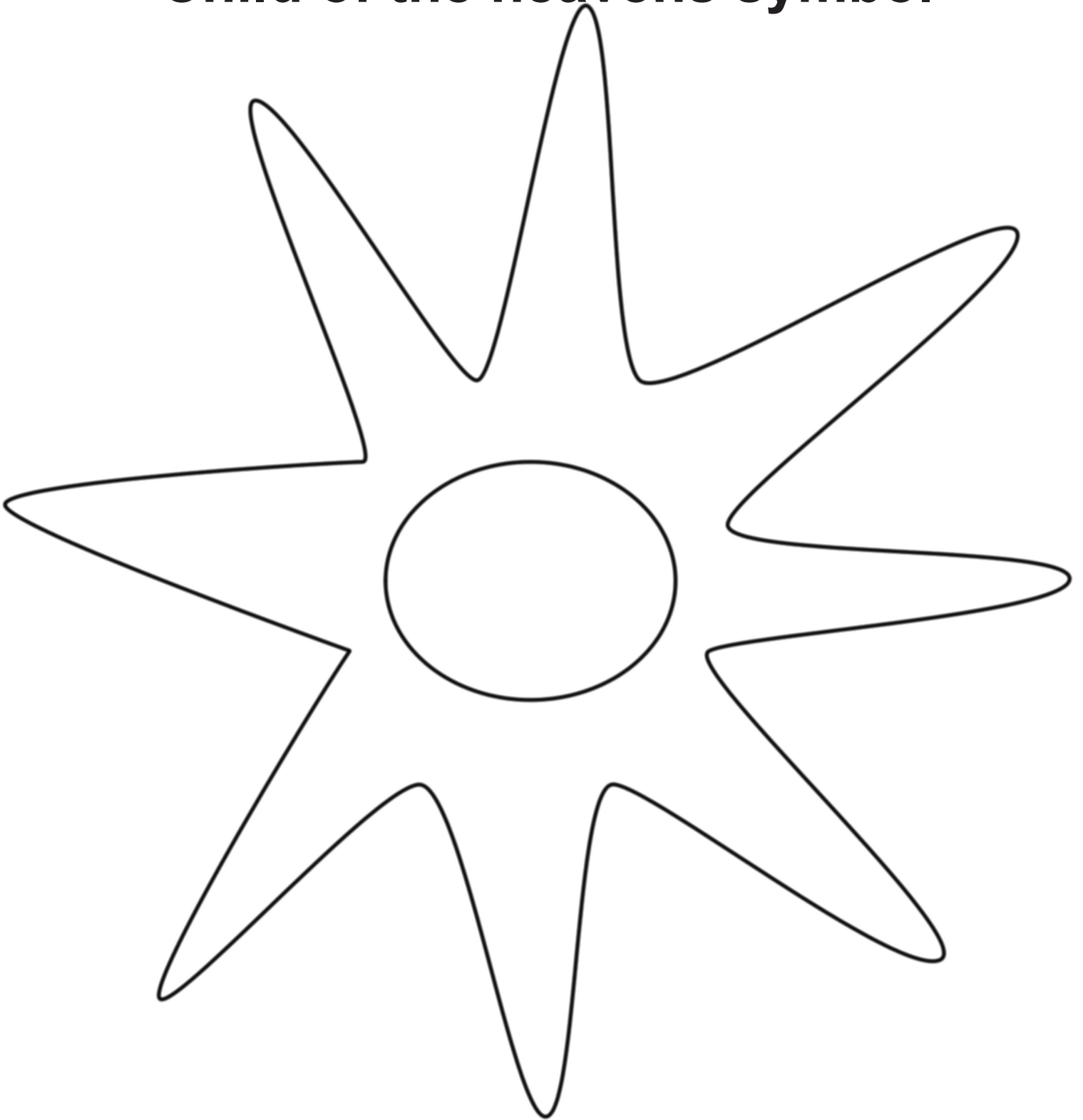

The above symbol is called “Nsoromma” in Twi (the language of the Adinkra people of Ghana). It means “child of the heavens”

# Mtoto doll

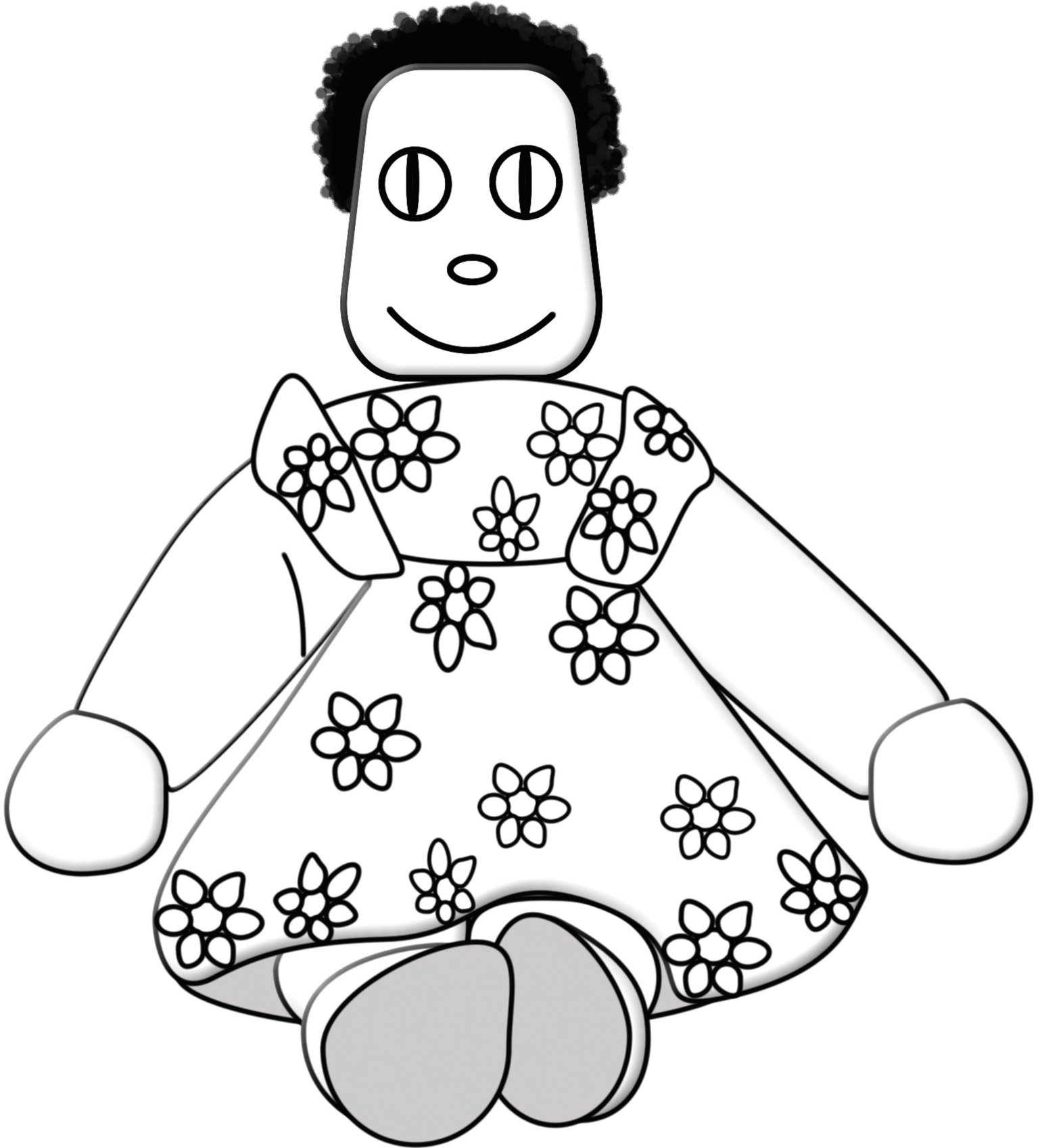

This is a “Mtoto” doll from East Africa. The word mtoto means “child in Swahili.

# Dumbek Drum

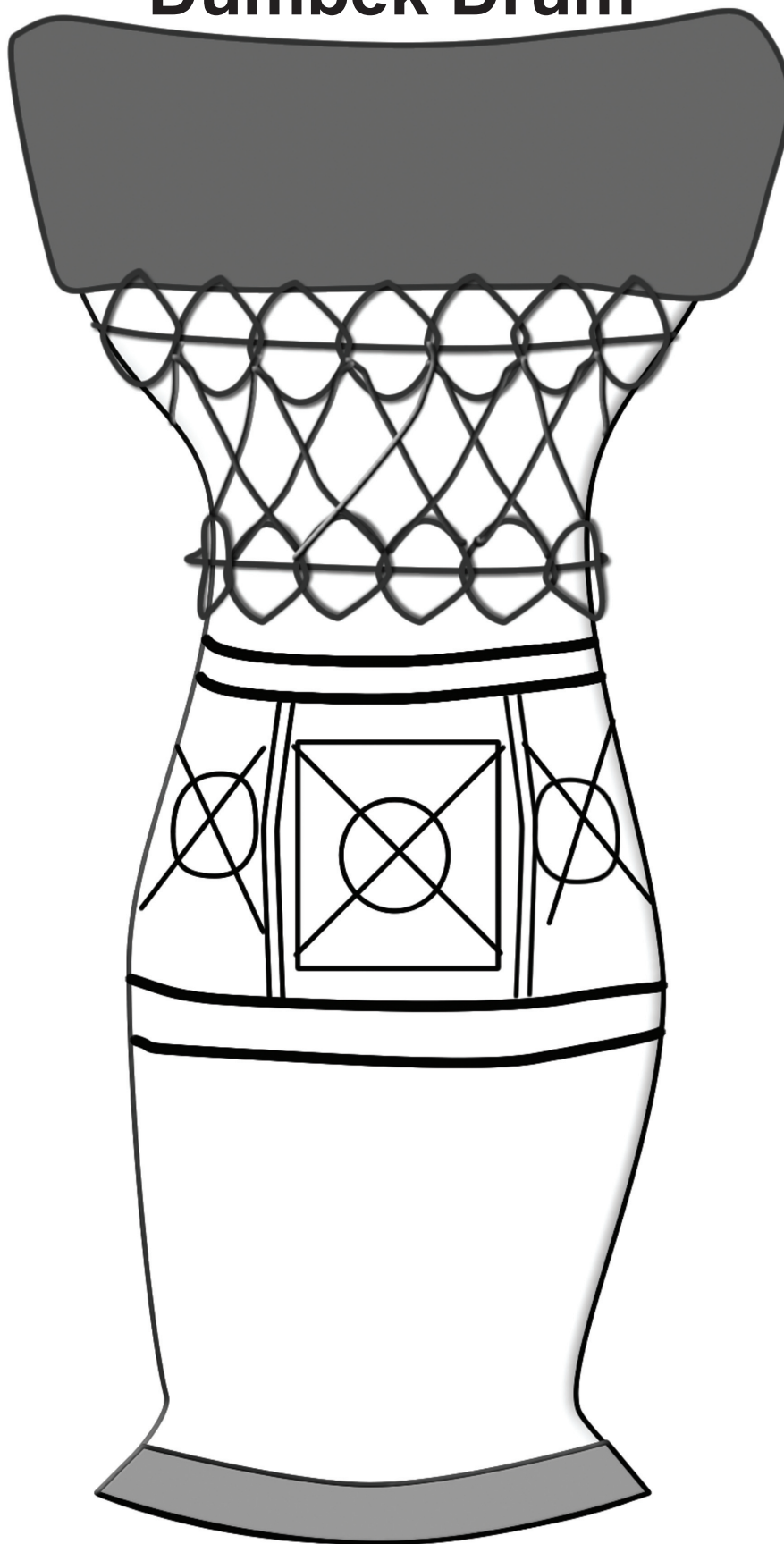

This African instrument is called a ceramic dumbek drum and is hand-made in Morocco.

# Bese Saka Symbol

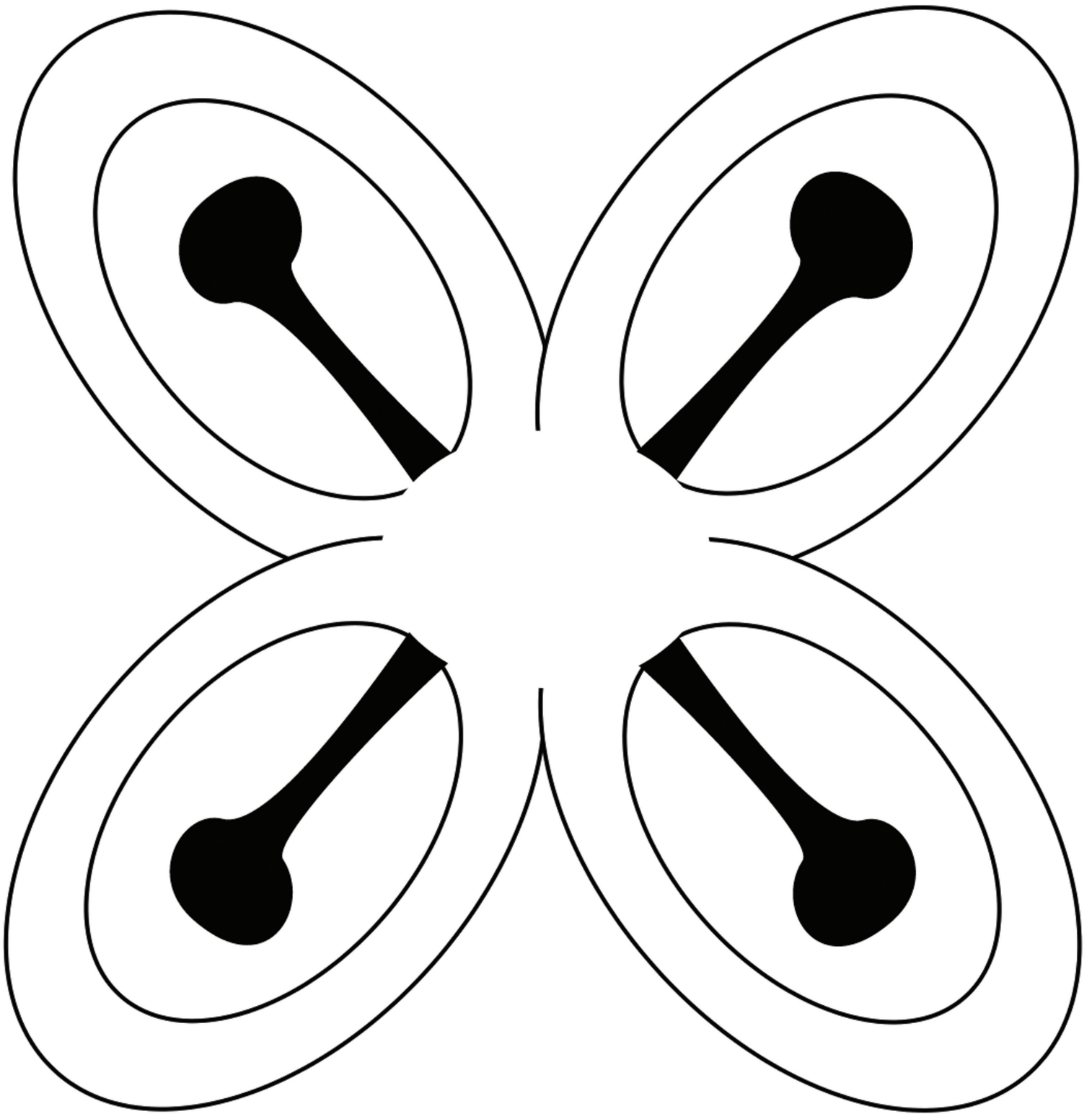

The Bese Saka symbol literally means “Sack of cola nuts”. This is a symbol of the Ashanti people. The cola nut is a symbol of money and unity.



# African Giraffe

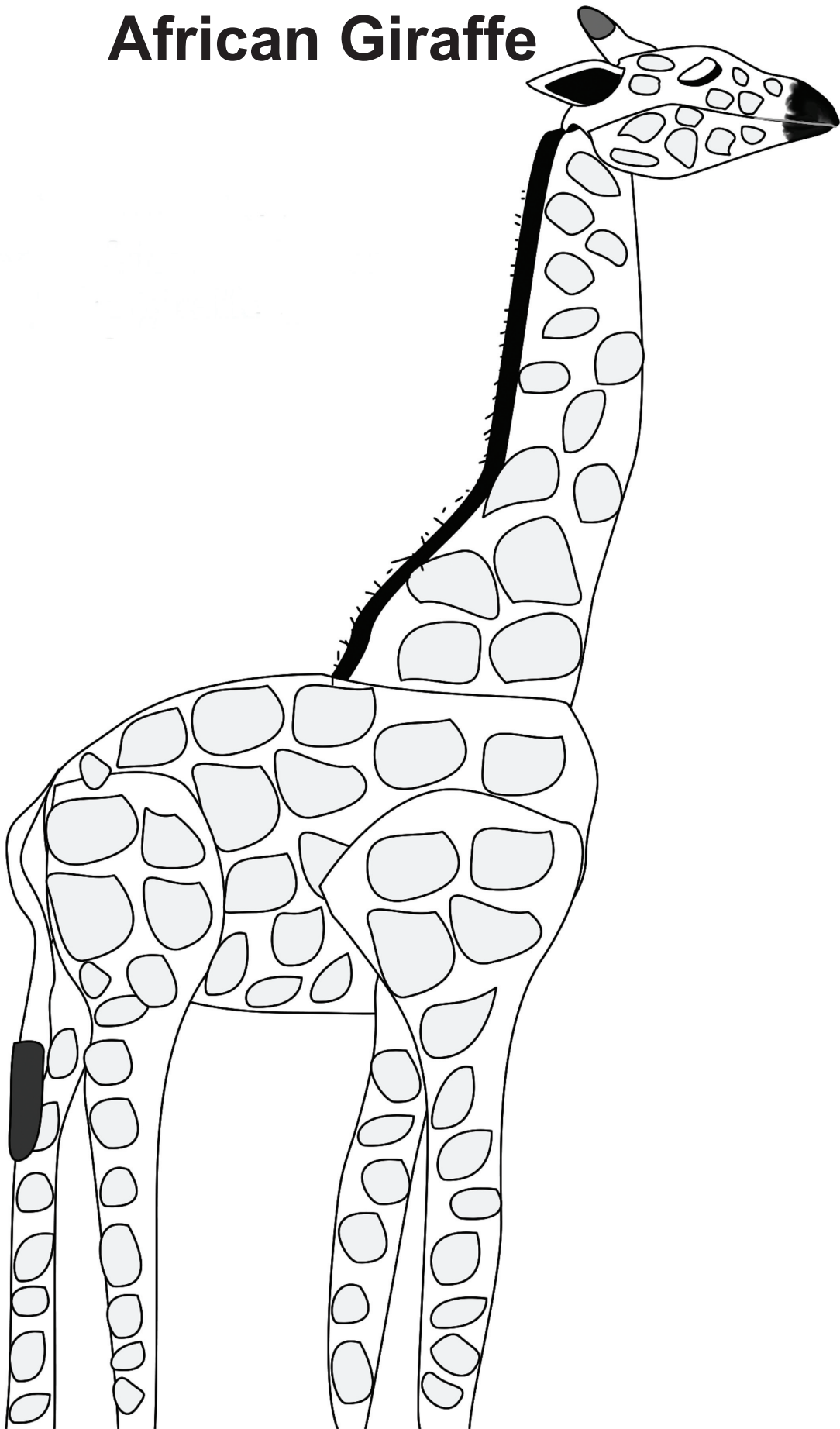

The Giraffe is the tallest land animal in the world.  
Ancient African cultures used to worship the giraffe.

# Double Zeze Guitar

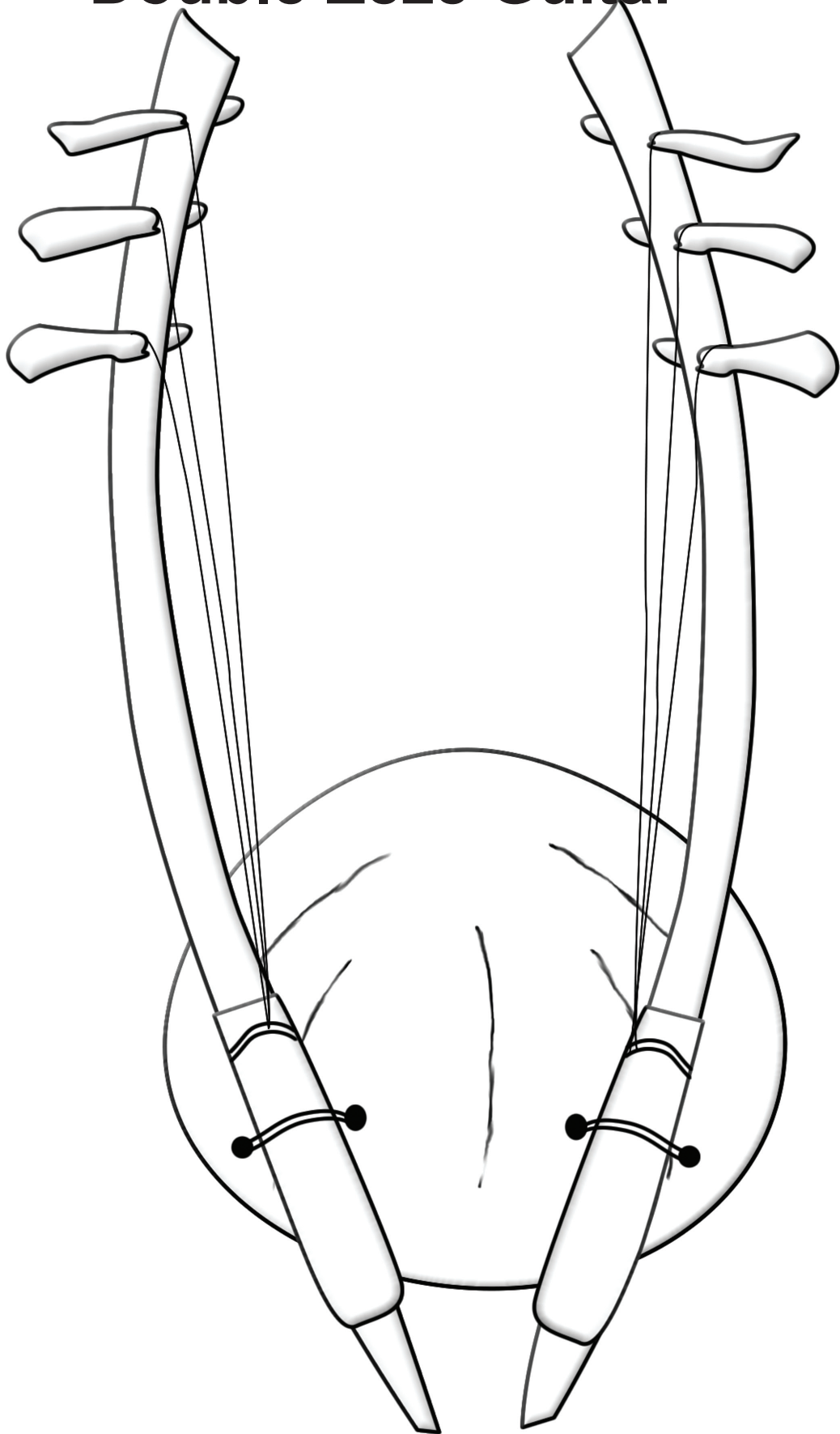

This African instrument is called a Double Zeze Guitar. This kind of guitar is made and played in Kenya, Africa.

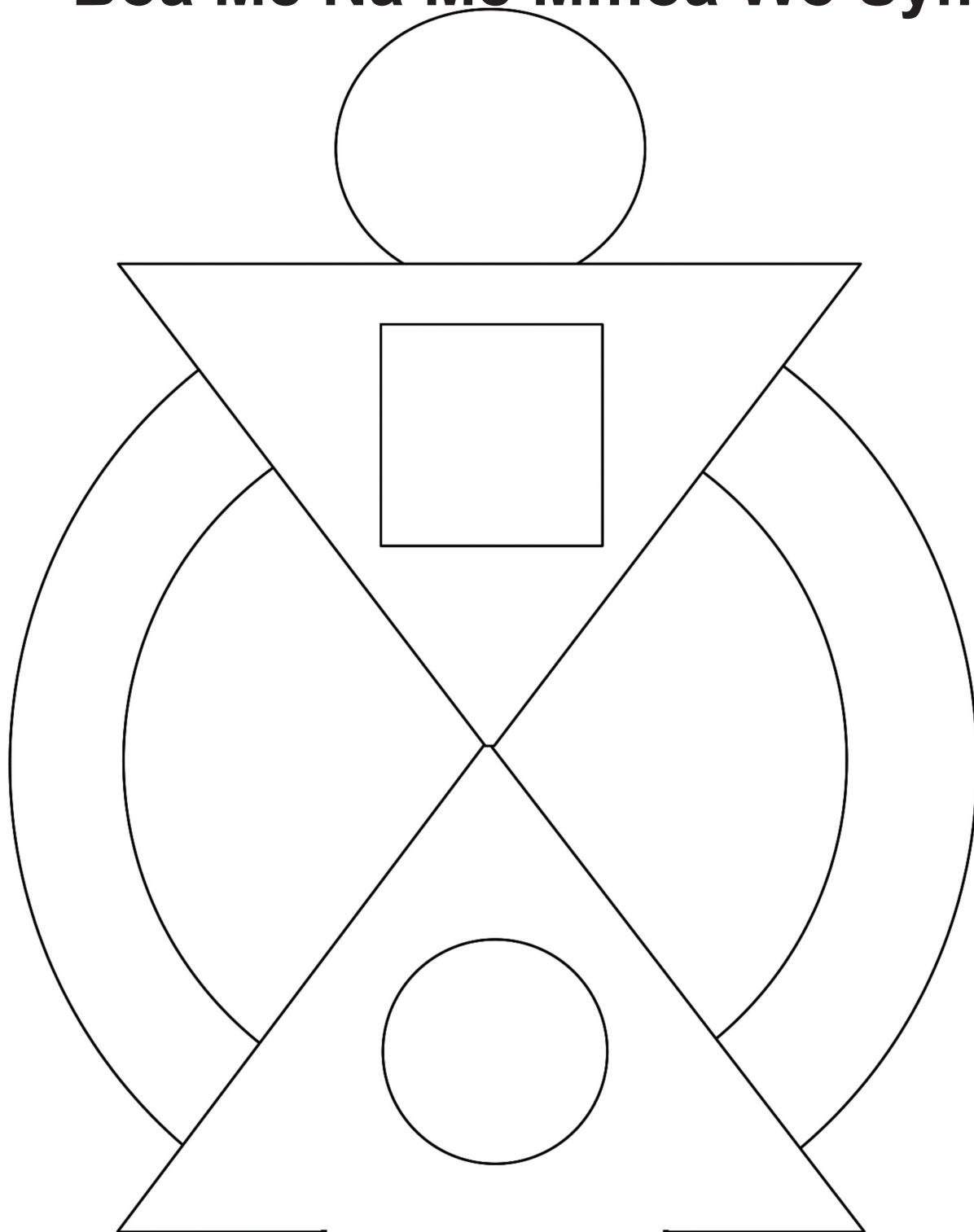

This symbol is called “Boa Me Na Me Mmoa Wo”, which means “Help me and let me help you.” This helps remind us to cooperate with others.

# Pyramids of Africa

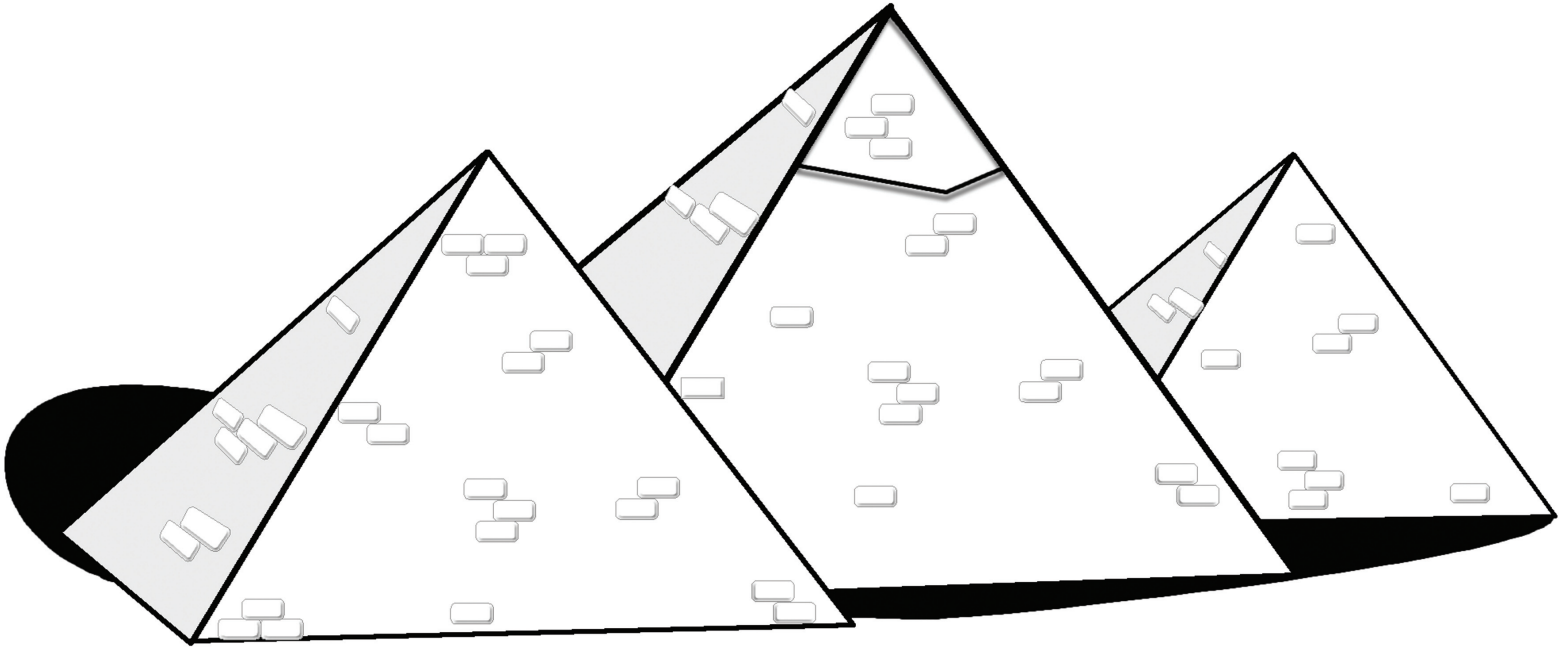

The pyramids in Egypt are actually tombs for some of the greatest pharaohs to ever exist. It is believed that the taller the pyramid is, the greater the pharaoh was.

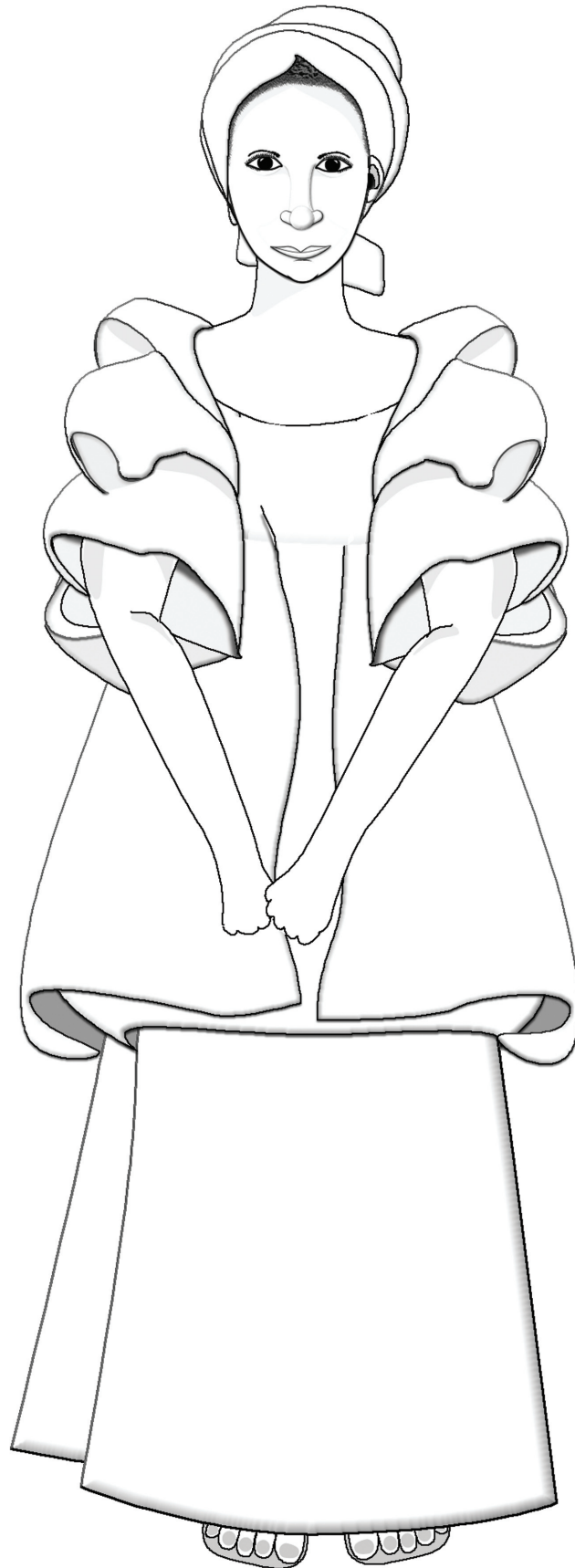

The African woman shown here is wearing the traditional brocade skirt set. These sets are often worn to events like weddings and festivals.

# African man

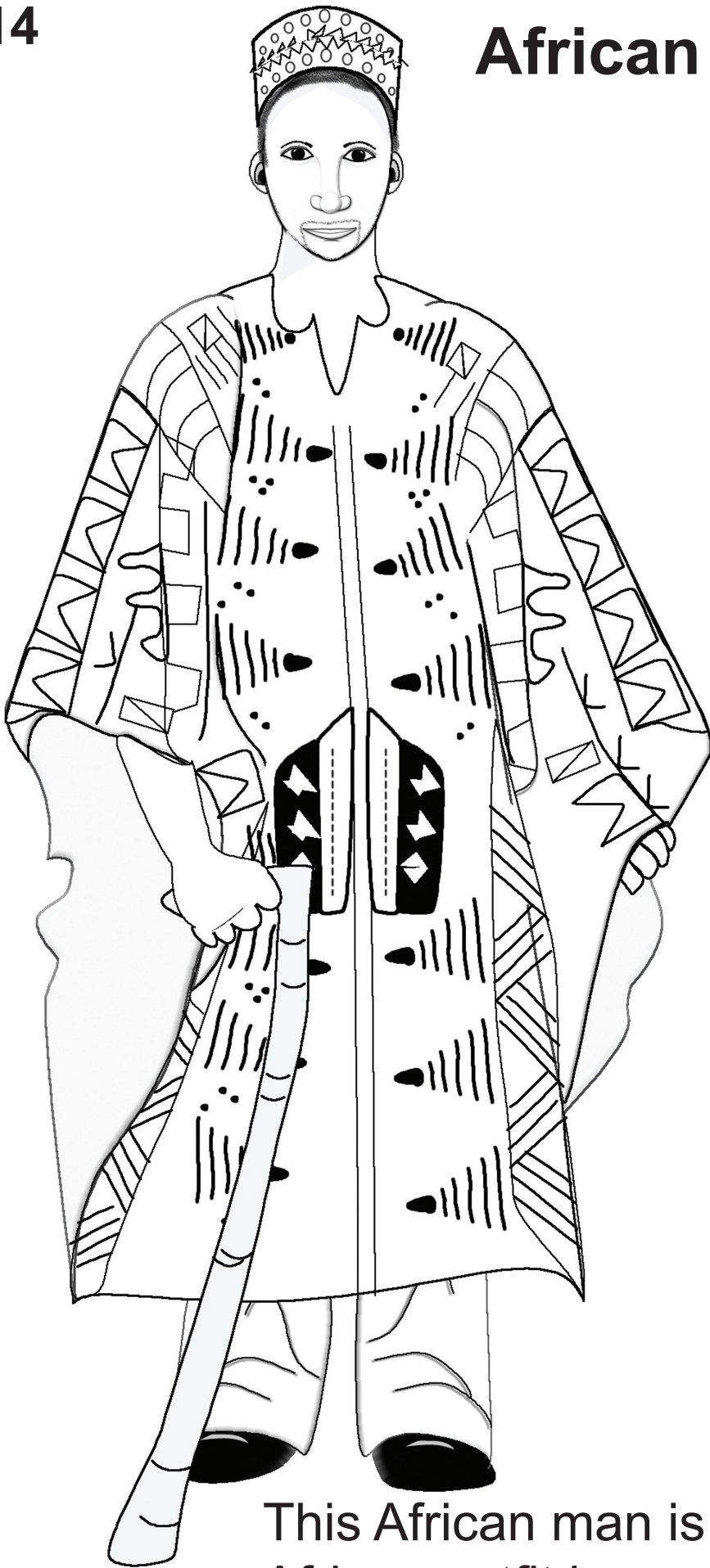

This African man is wearing the traditional African outfit known as the “boubou”

# the African hippopotamus

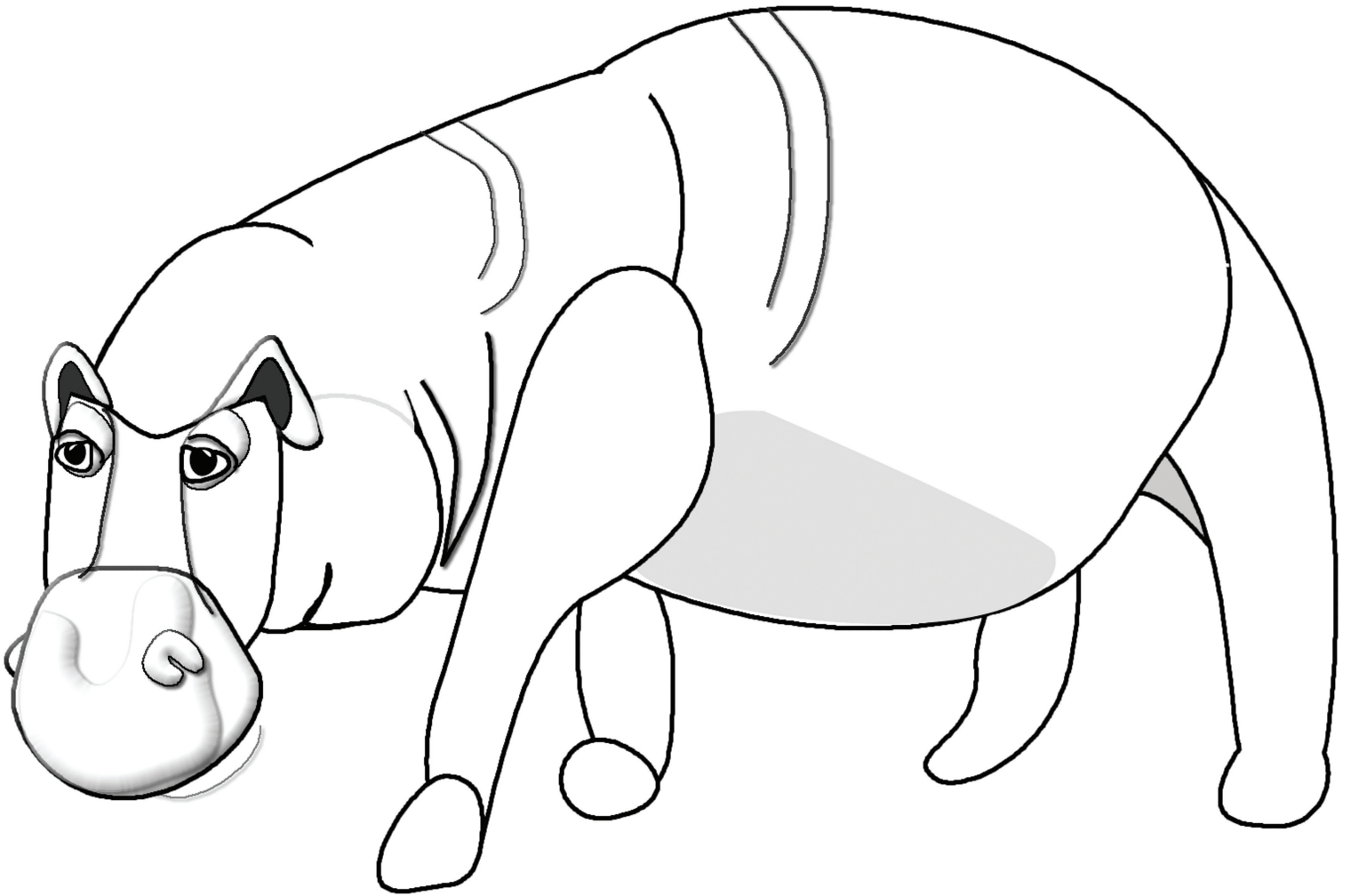

The hippopotamus lives in East Africa. The hippo spends most of the day in the water. It can stay under water for 6 minutes! The hippo's name in Swahili is Kiboko.

## The symbol of love

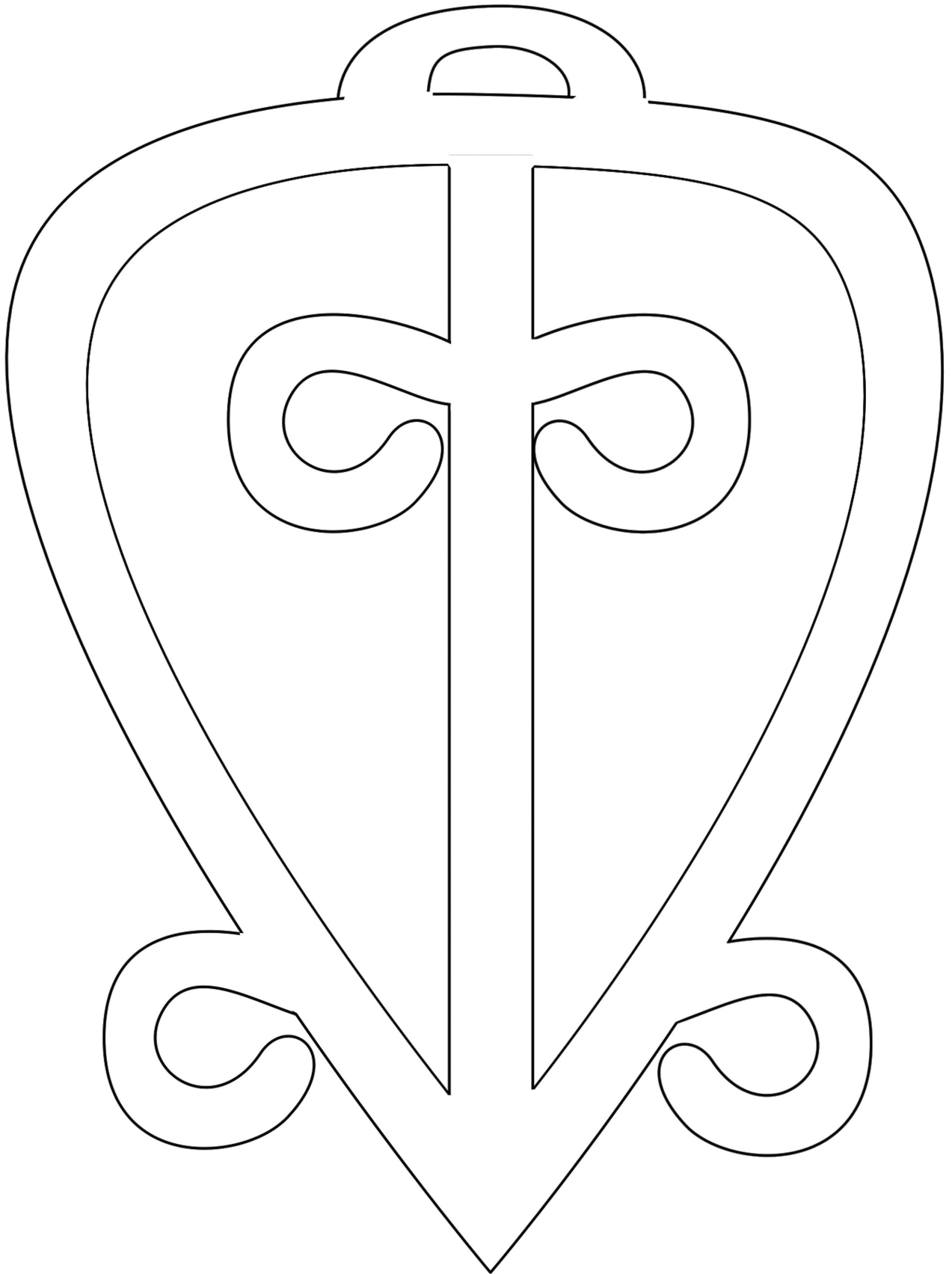

This symbol is called “Odo Nnyew Fie Kwan, which means “Love never loses its way home”. This reminds us of the power of love.



# The house symbol

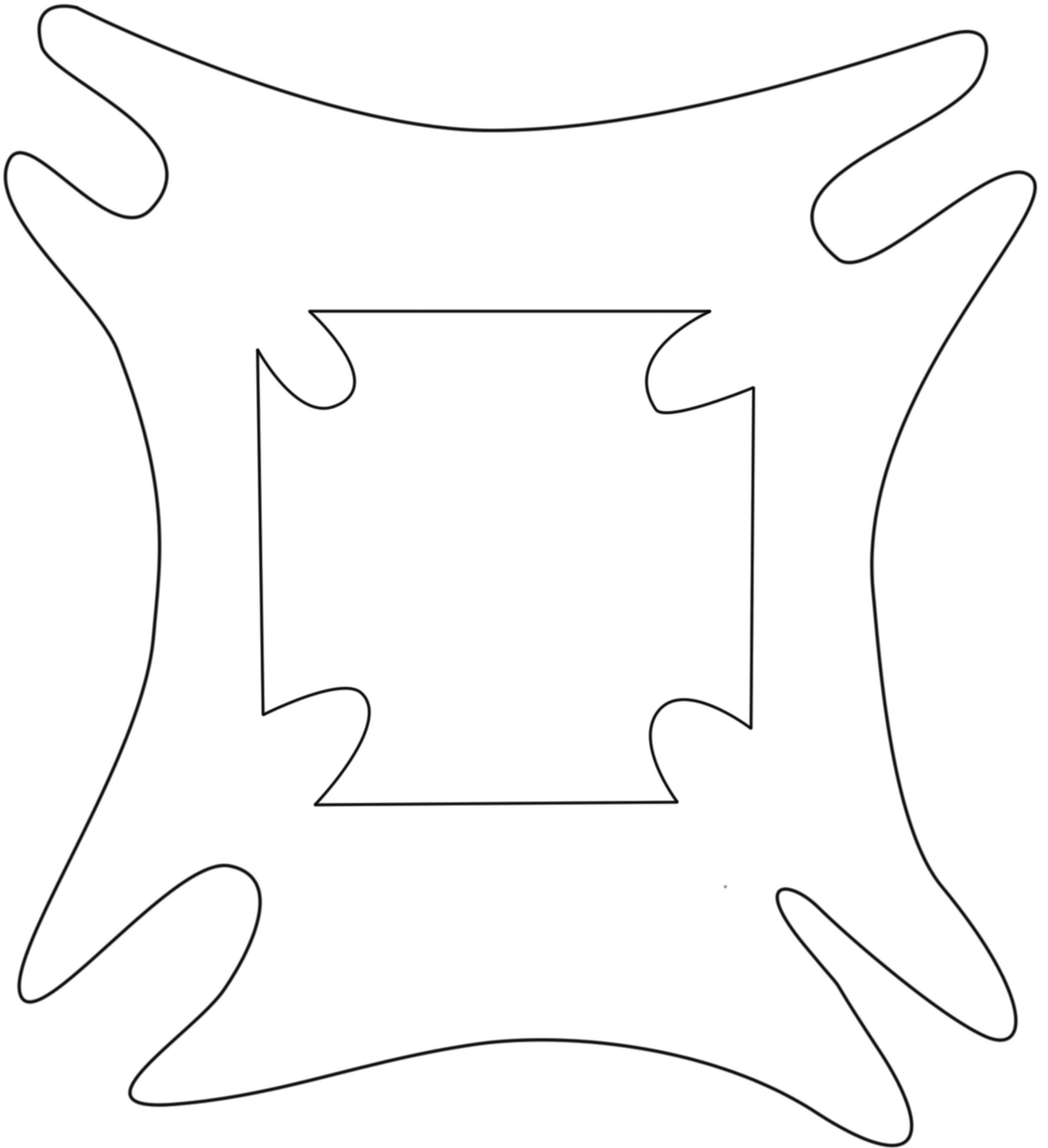

This symbol is called “Fihankra”, which means “house.” This sign symbolizes safety. The hole in the middle represents the door of houses.

# African man playing drums



This African man is playing an African drum. Drums are used in ceremonies and celebrations. People in Africa play drums at weddings and at church.



This West Africa doll shows one way African mothers carry their babies.

# The Rhinoceros of Africa

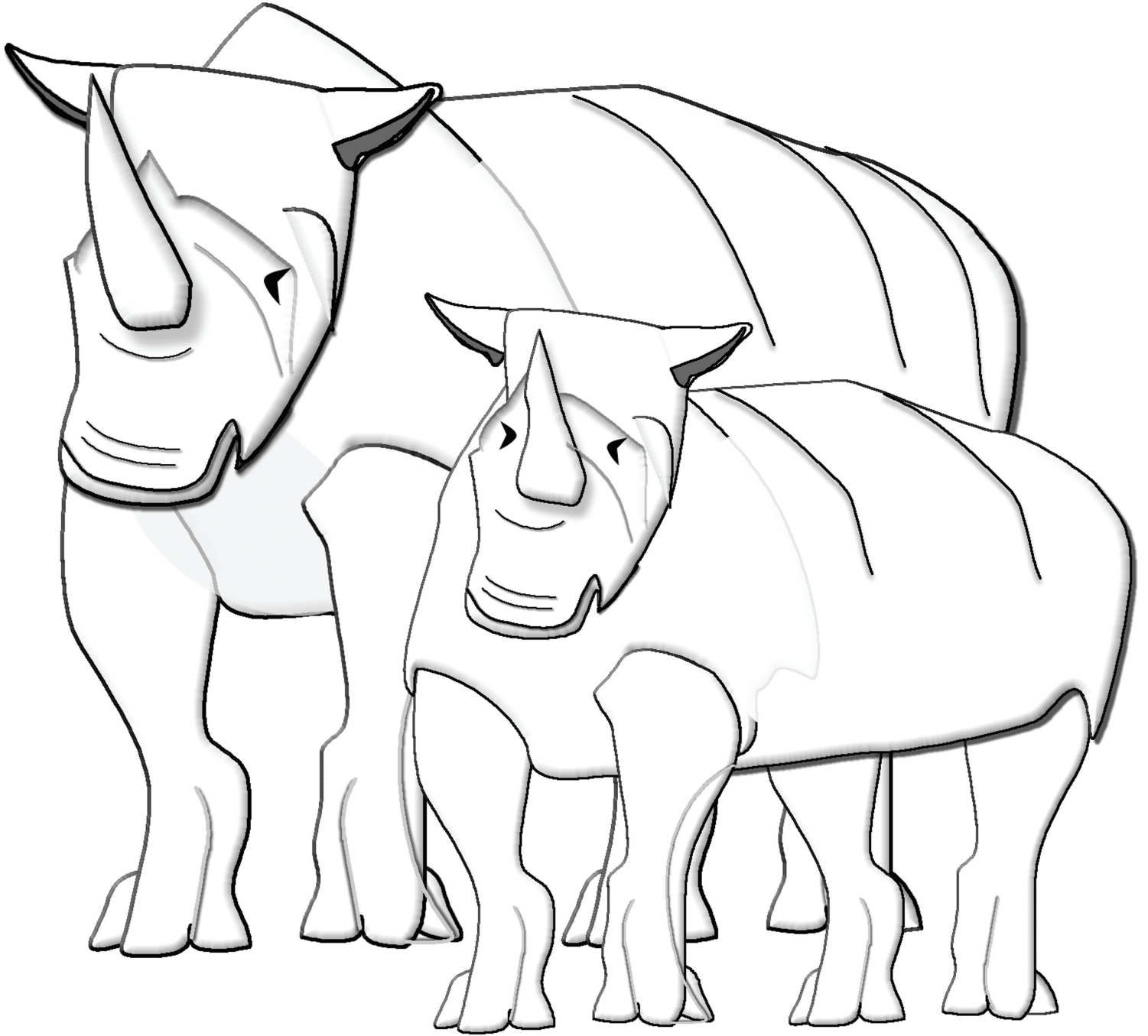

The rhinoceros lives mostly in the Democratic Republic of the Congo in Central Africa. The rhino can be found in the grasslands of Africa, where it eats many different kinds of vegetables. The rhino's name in Swahili is "Faru"

# The “Tamfo Bebre” Symbol

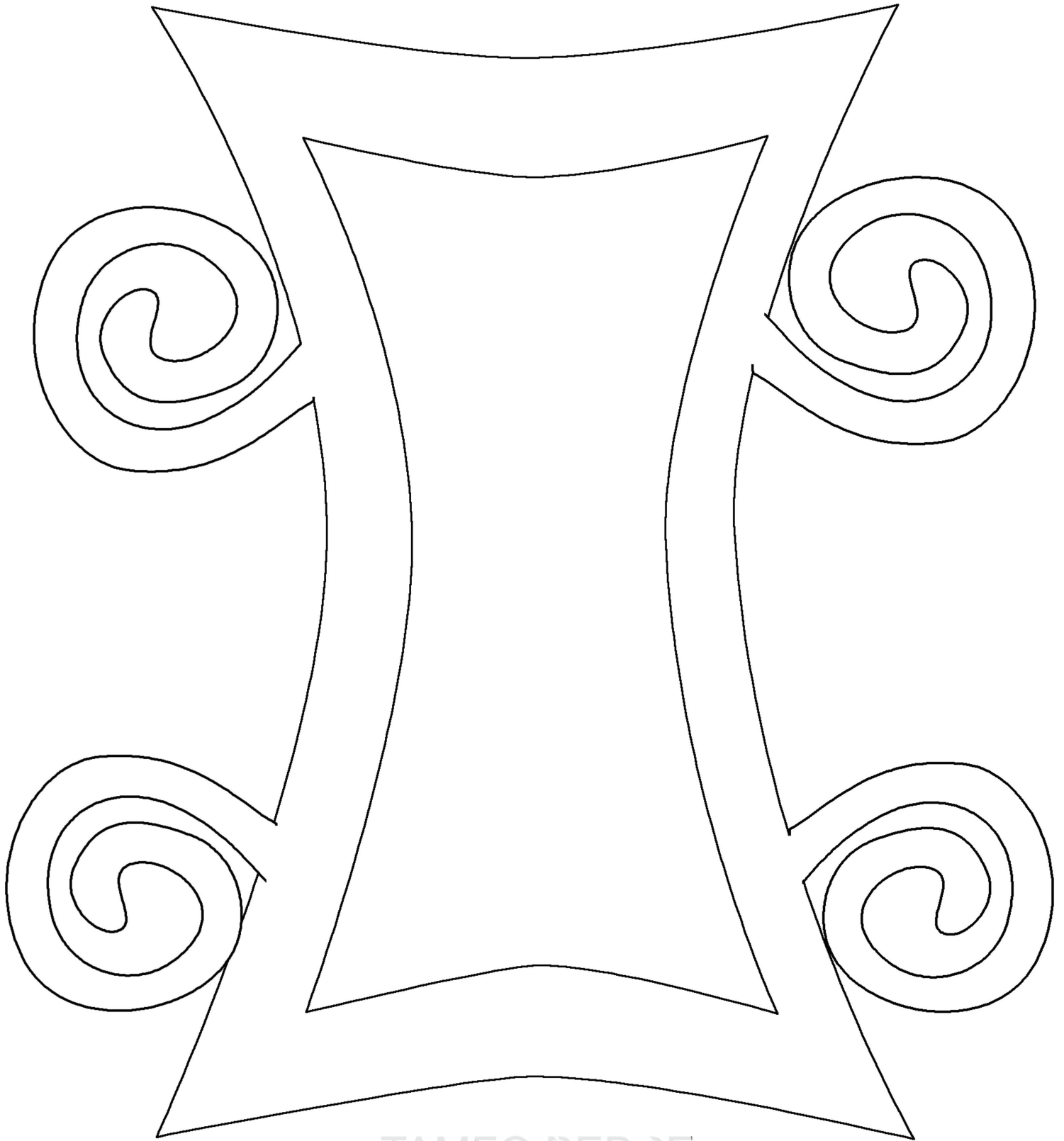

The name of this symbol means “The bad things that people do will happen to them too.” This Adinkra symbol teaches us to learn from the past

# African Hut

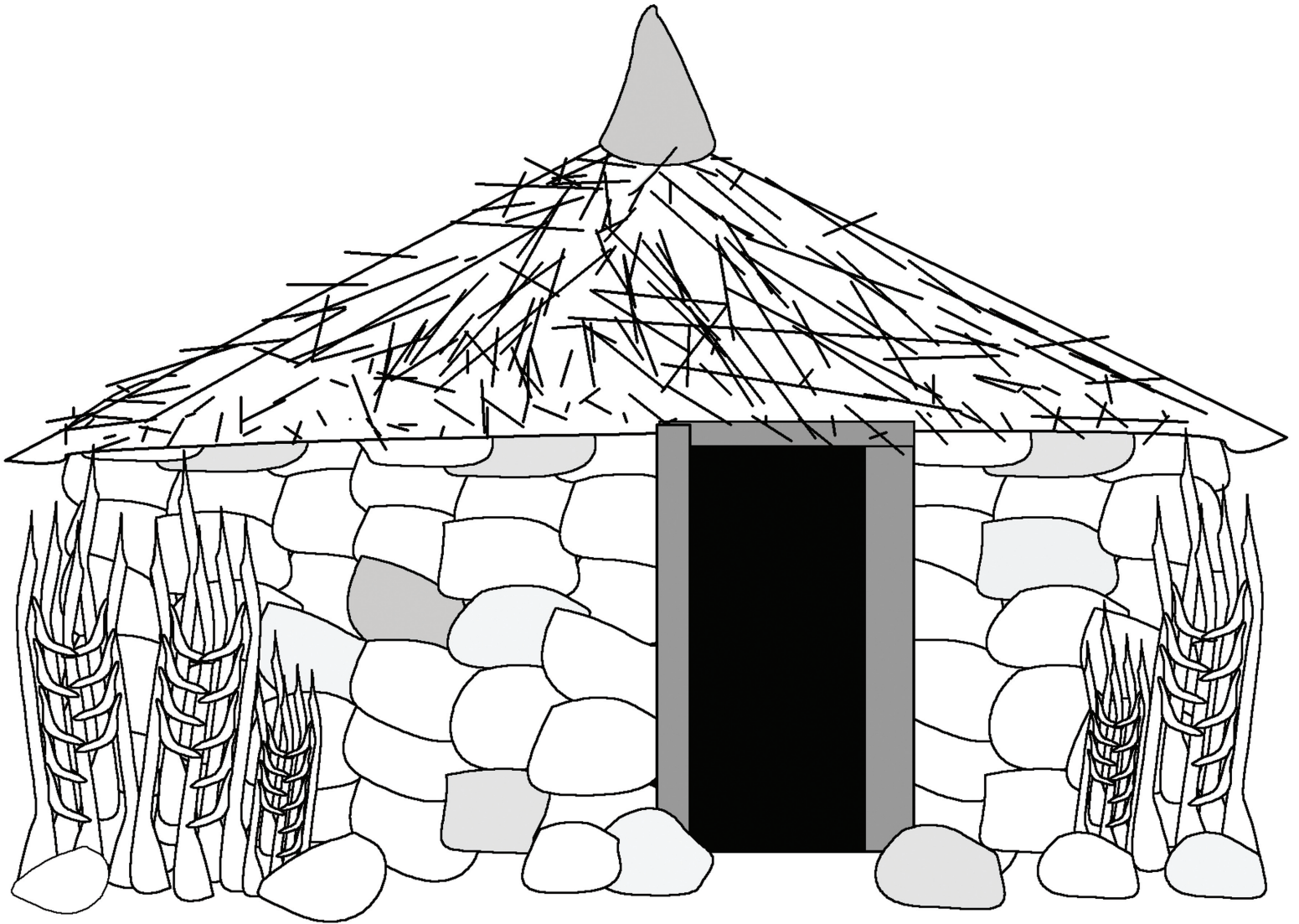

In many countries, families live in small huts. Some African huts are made of mud bricks. The roofs are made with hay and straw.

# Calabash Shakera

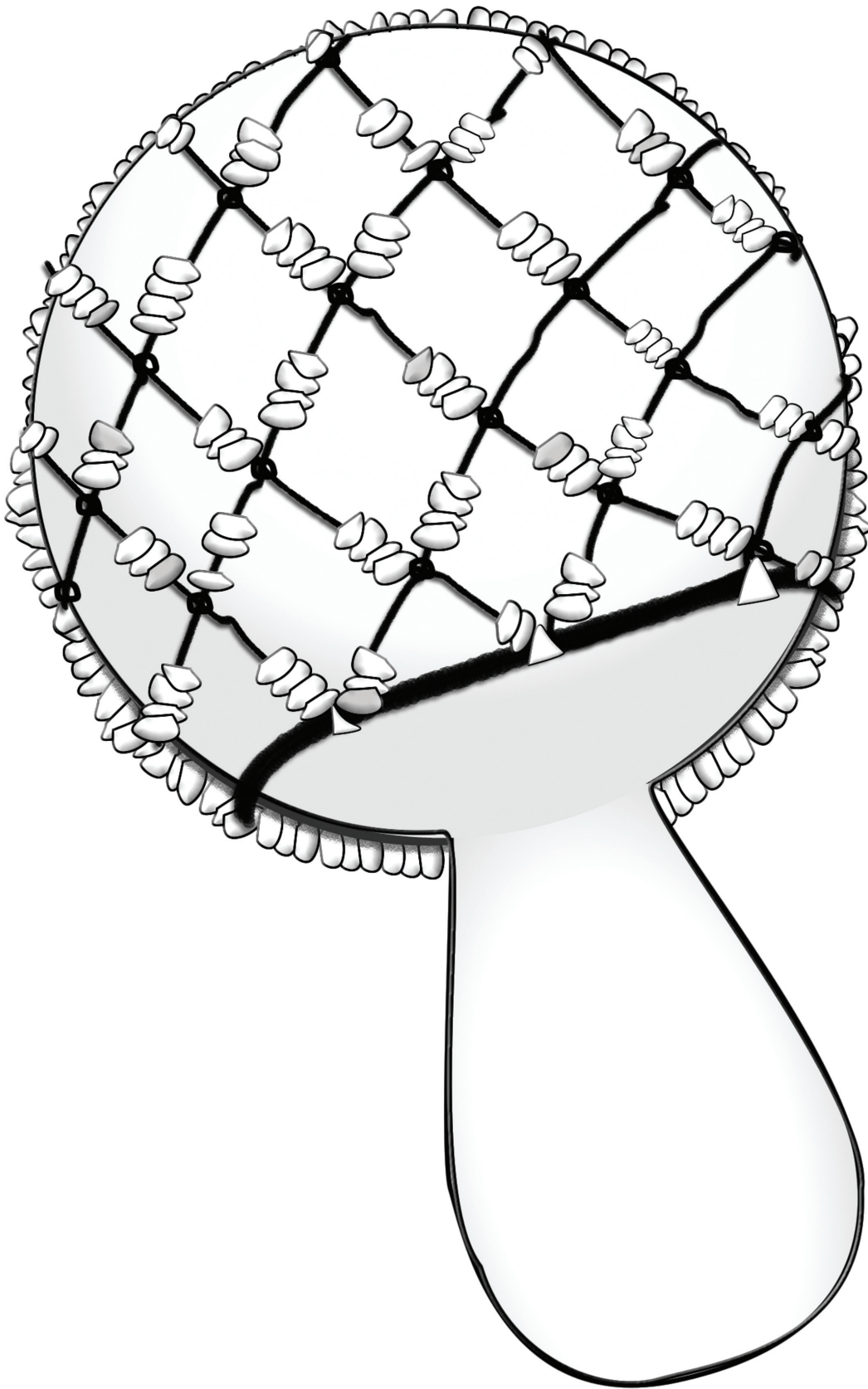

This calabash shakera is often played as a musical instrument.

# Wooden Agogo Bell

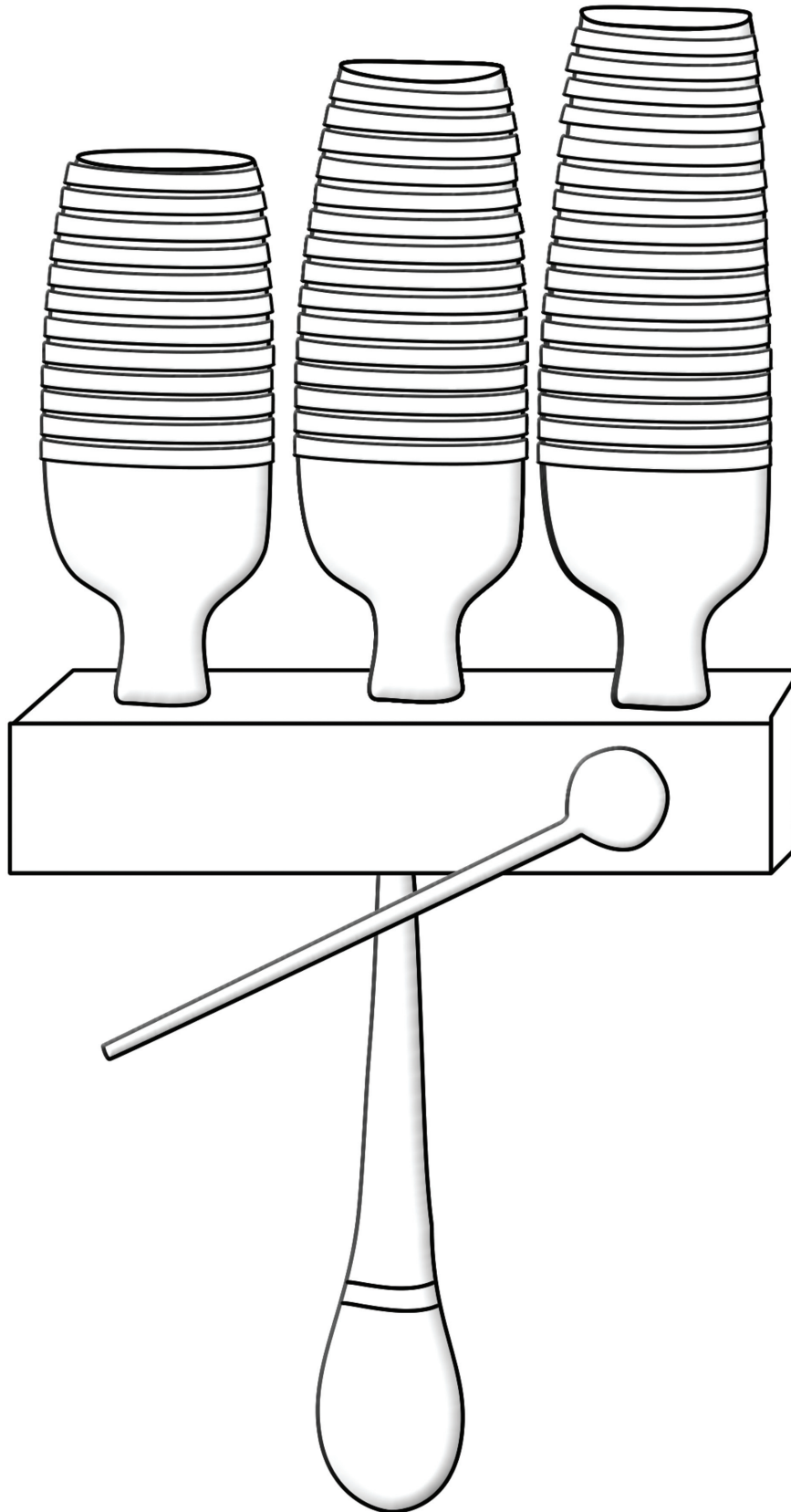

This African instrument is called an Agogo Bell. It is made out of three wooden or metal tubes. Each tube makes a different sound.





In Africa, many girls help their mothers buying food and preparing meals for the family. This mother and daughter are carrying their food home from the market.

# African elephant

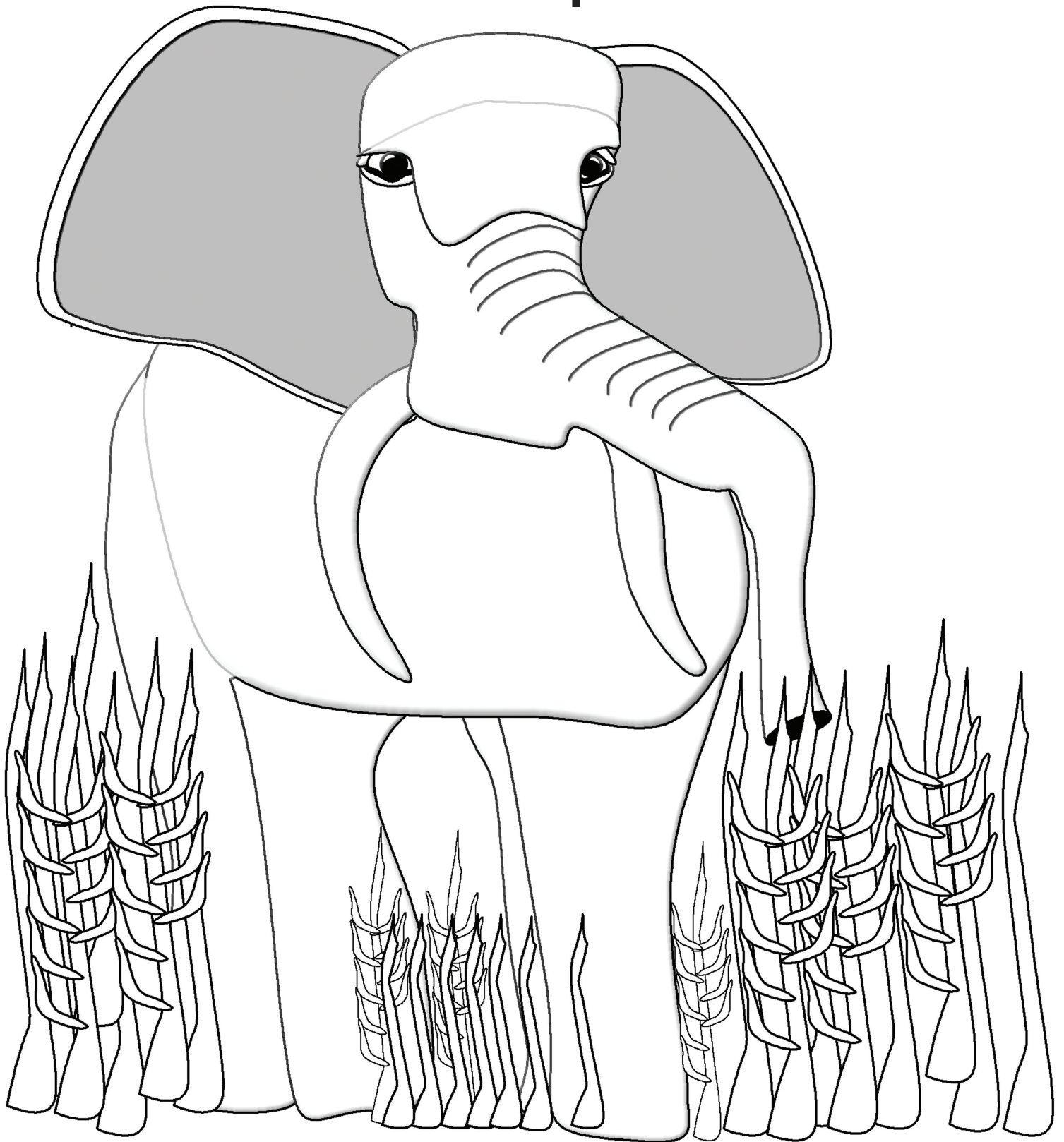

The elephant's name in Swahili is "Tembo" or "Ndovu". It is between 8 and 11 feet tall and weighs between 4,000 and 13,000 pounds!

## African lizard toy

27

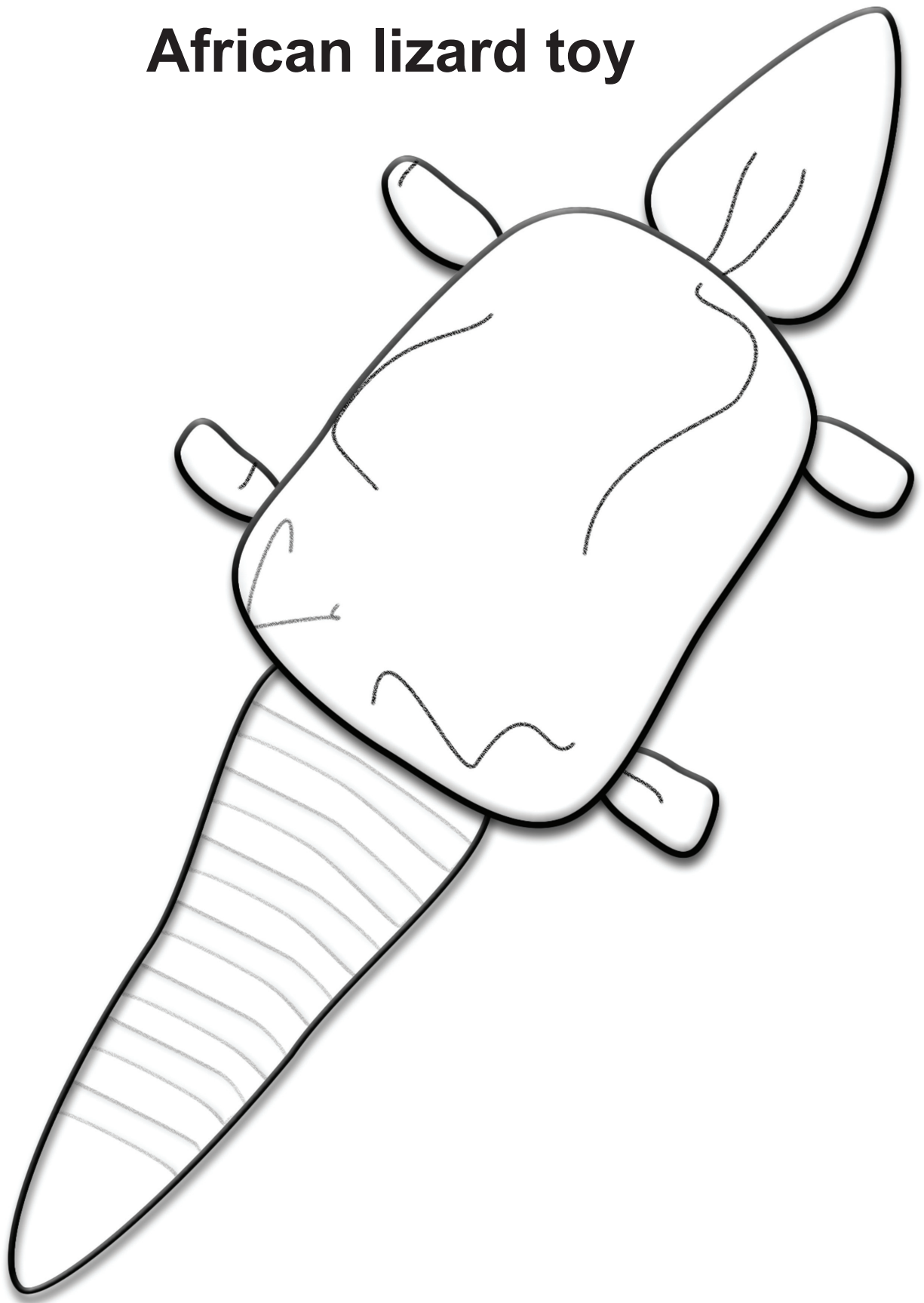

Many African children make their own toys. This toy lizard is just like the ones made out of clay by the children in Morocco.



# Flag of Liberia

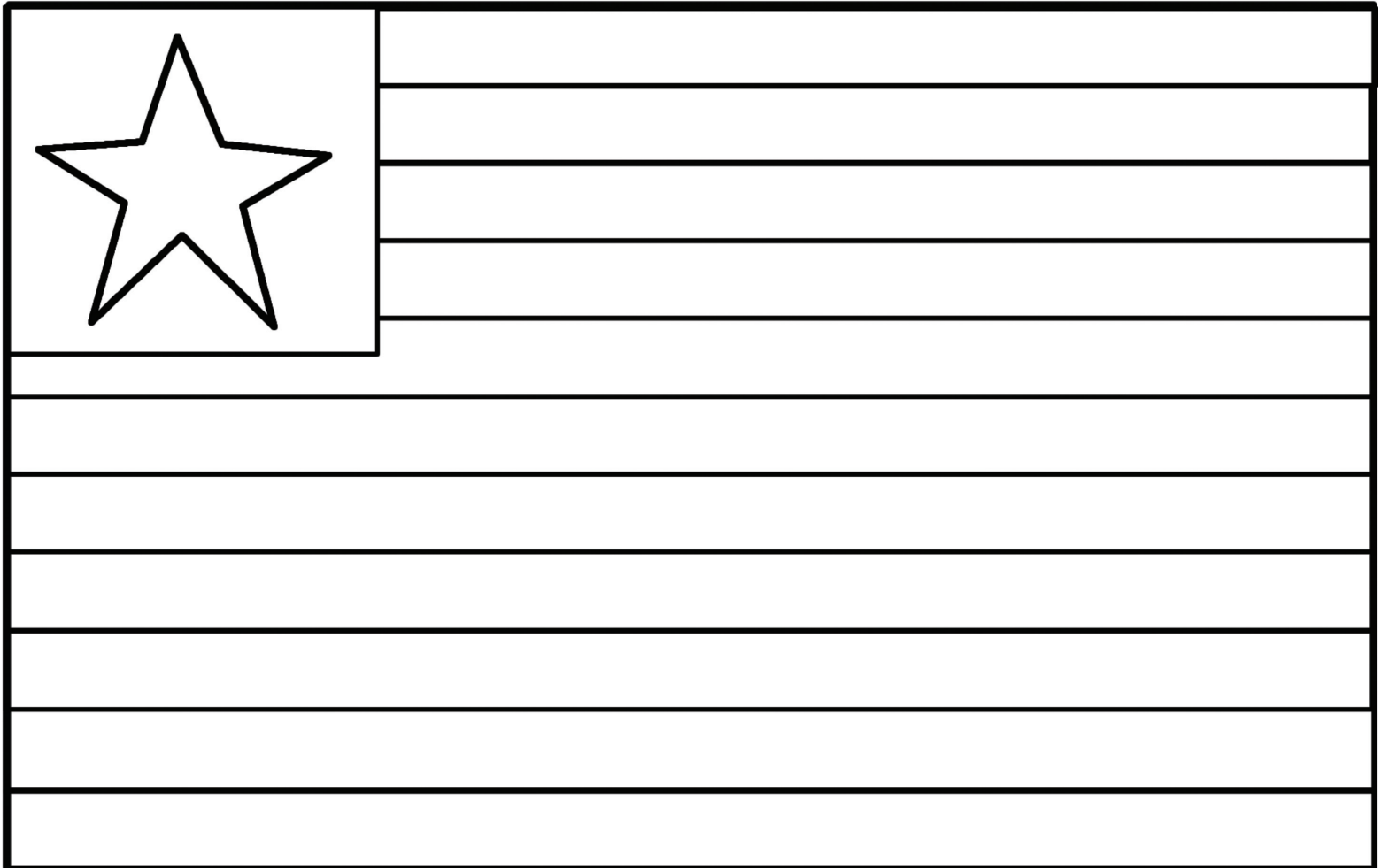

The lion lives in grassy plains and eats other animals. A group of lions is called a pride. The lion's name in Swahili is "Simba."



## Childrens Drum

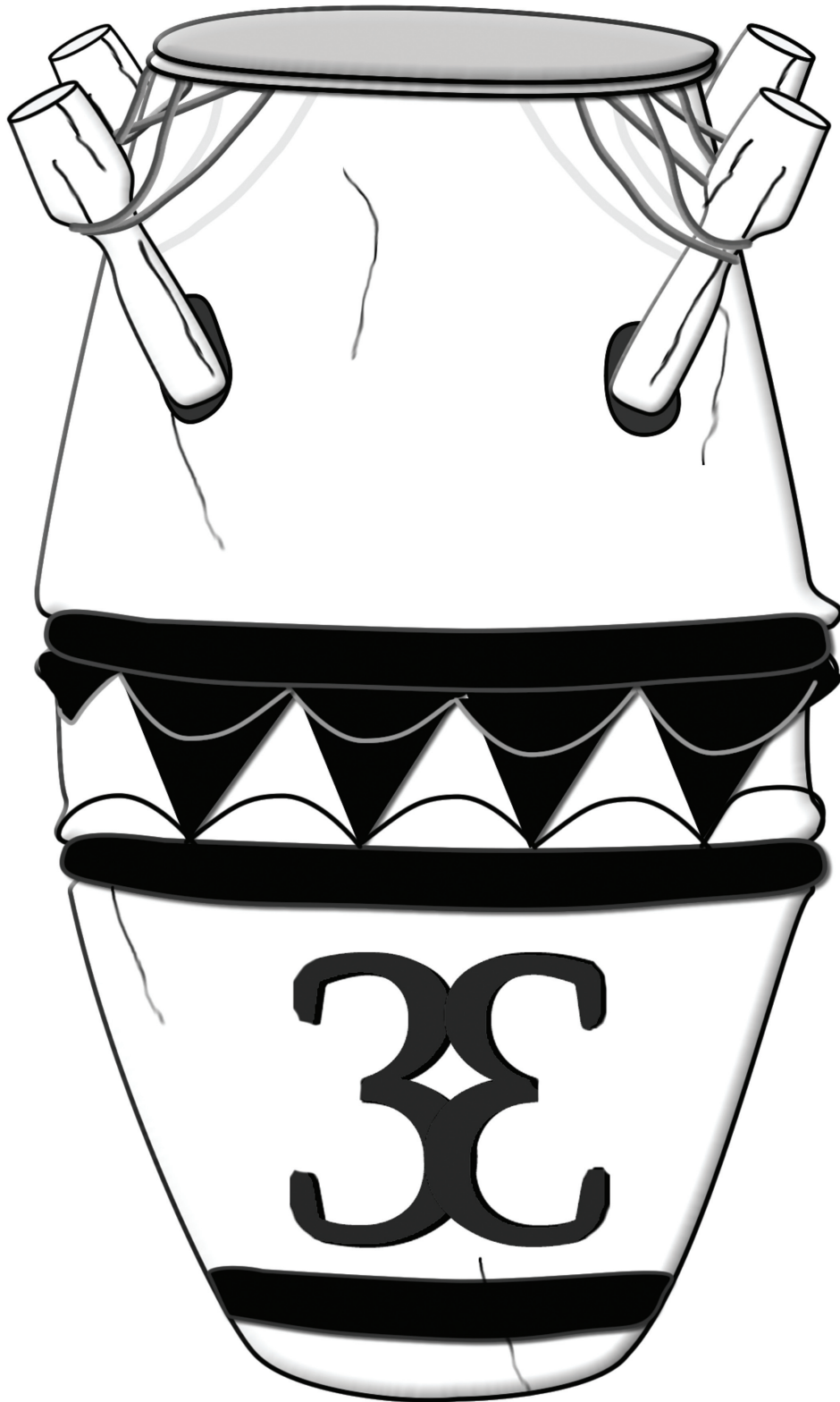

This African instrument is called a Kpanlogo. It was first made by the people of Ghana in West Africa. The top of the drum is often made with cow skin. The drum can be played either with your hands or with sticks.

# Flag of Kenya

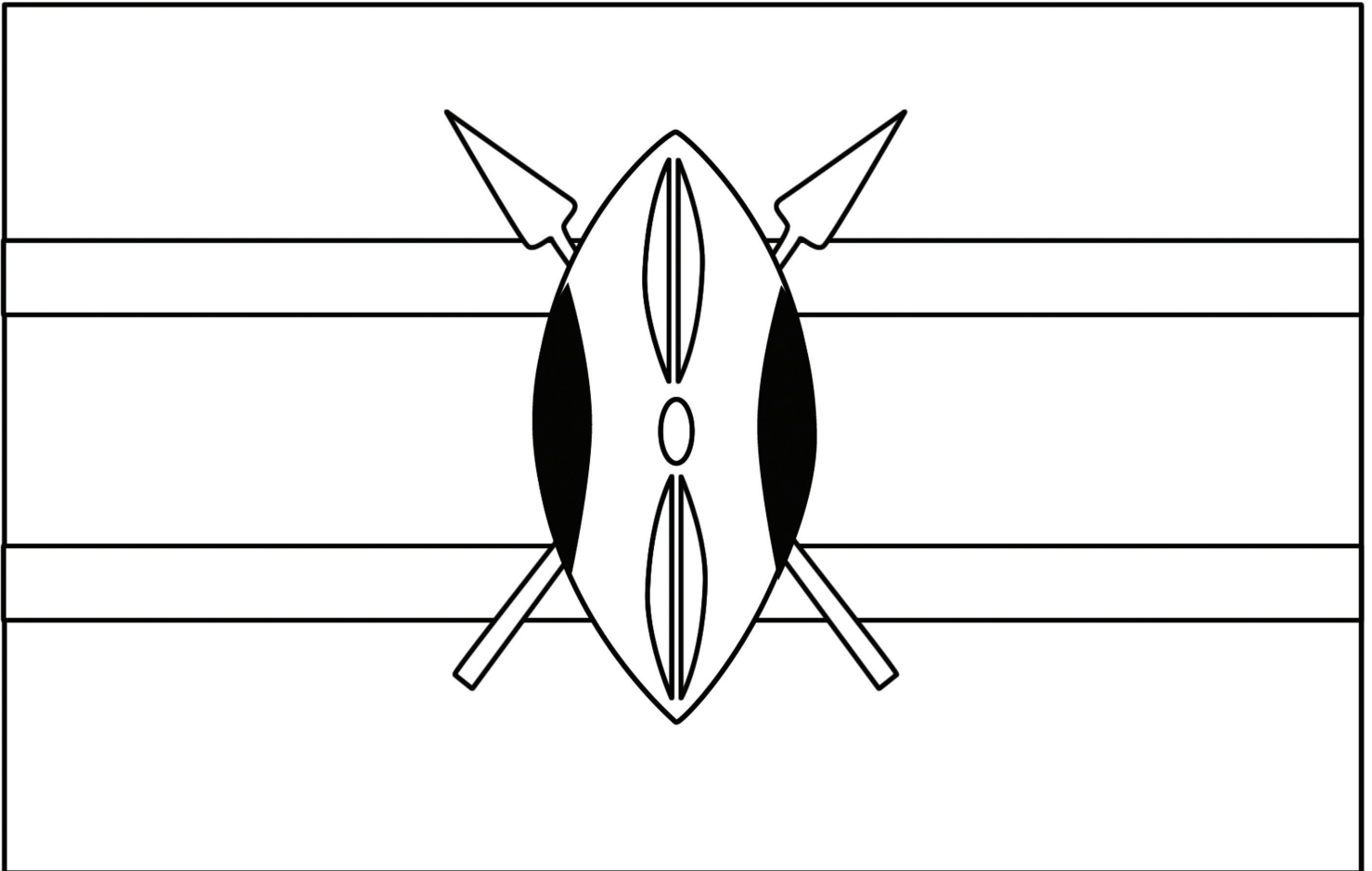

Kenya is a country on the eastern tip of Africa

32 **Gye Nyame - “Except for God”**

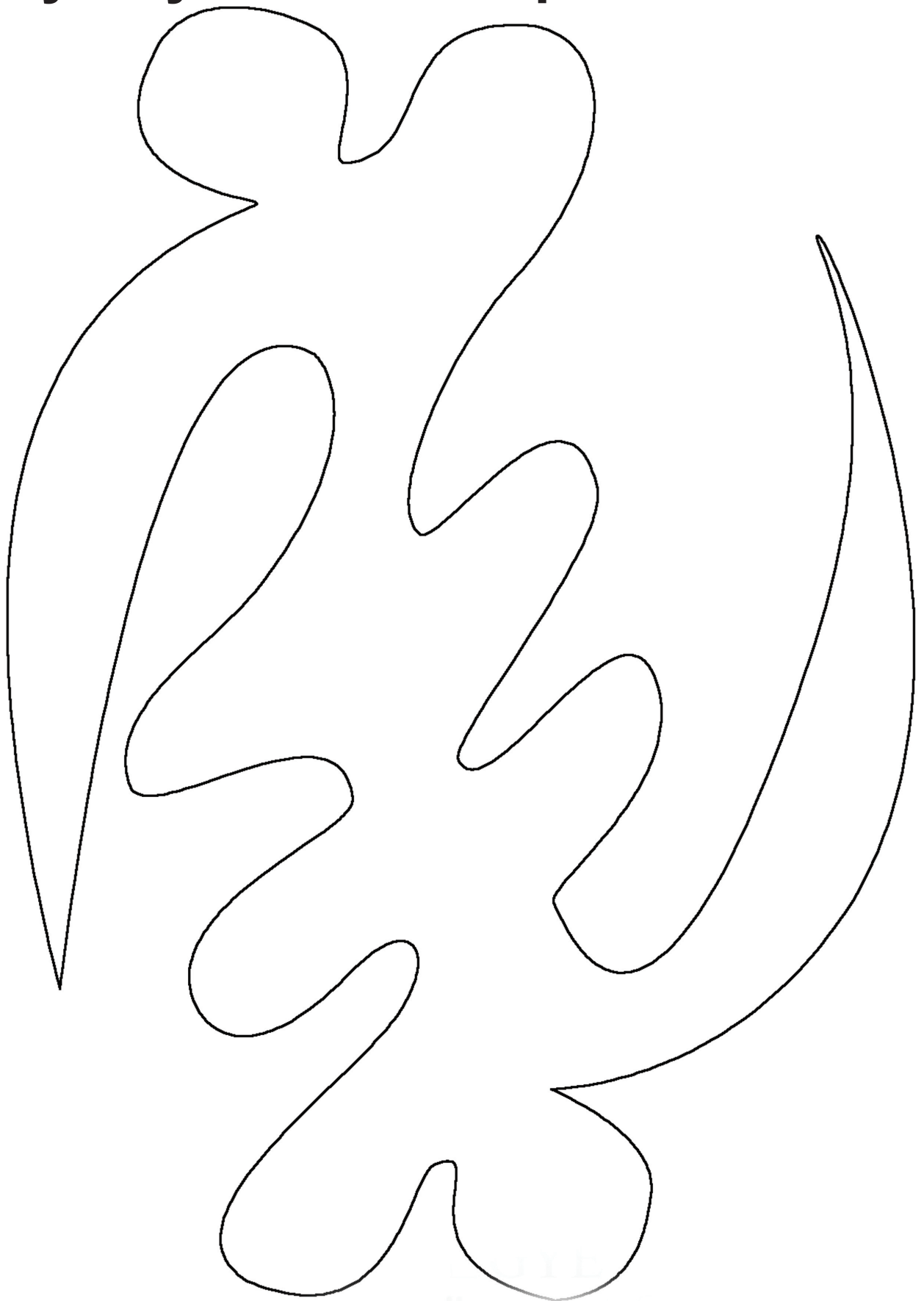

This symbol shows that God is in control of everything. It comes from Ghana.





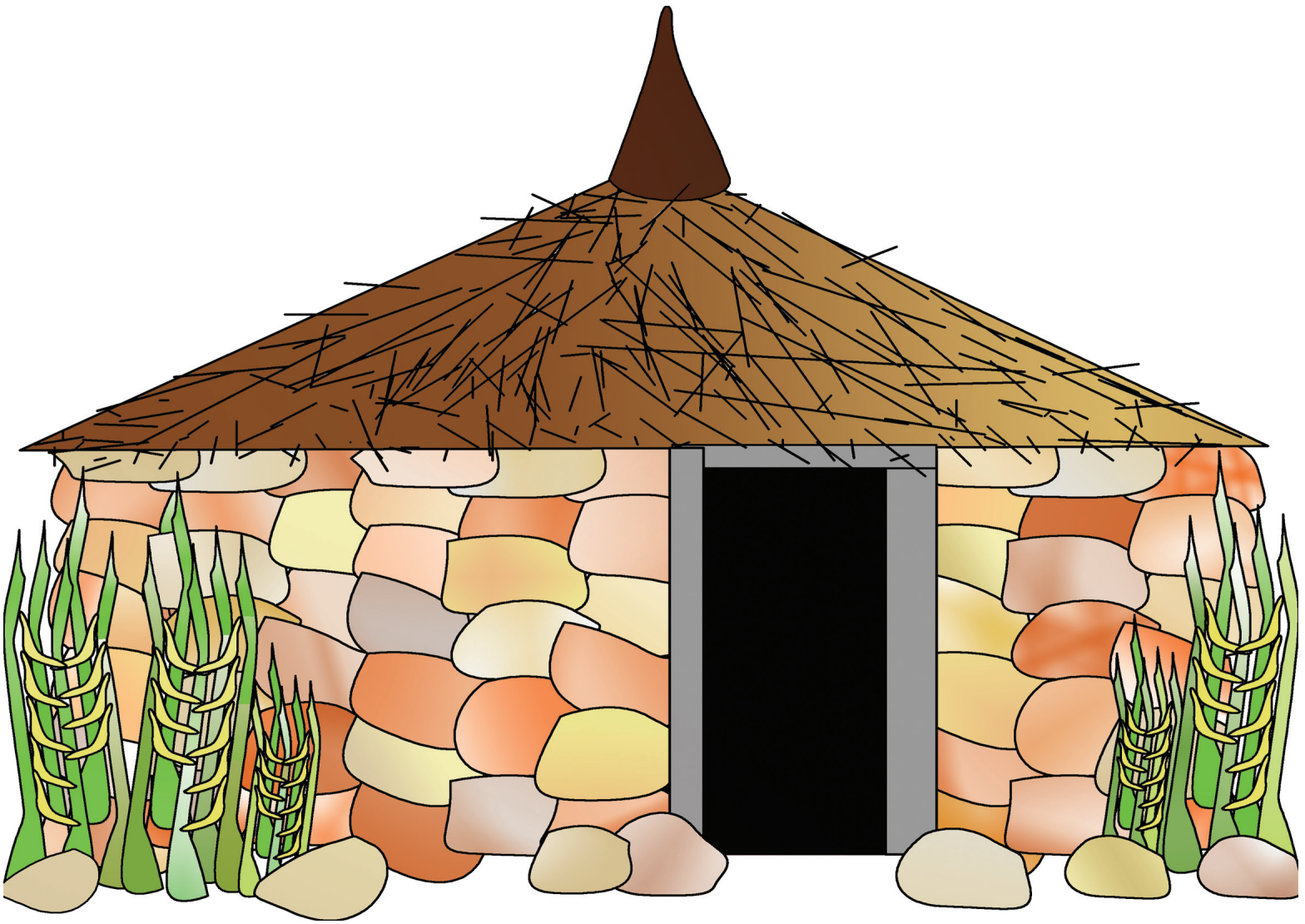

## **Africa Coloring Book**

*Wayne Kiltz and Christy Wetmore*

Discover things you never knew about life in Africa. In this book you will learn about African animals, African flags, and special African symbols.

Find out what Africa is like. Make pictures that help your friends and family know more about Africa. Most of all, have a lot of fun coloring while you do.

This book shows young people more things about Africa than some grownups even know. This book gives you a better appreciation of African culture. It also helps you to understand what things happen in Africa, and what it is like. And it gives this all to you in a way that is fun and easy to remember.

*Africa Coloring Book* is a new work, first published by Africa Imports in 2005

Manufactured in the United States of America  
Africa Imports, 240 South Main St. Unit A, South Hackensack, NJ, 07606

Copyright © 2005 by Africa Imports  
All rights reserved

Without limiting the rights under copyright reserved above, no part of this publication may be reproduced, stored in or introduced into a retrieval system, or transmitted, in any form, without the prior written permission of both the copyright owner and the above publisher of this book.